

Listino prezzi in punti

1 Punto = 1,10 € IVA esclusa

Price list in points

1 Point = 1,10 € excluding VAT

Preisliste in Punkten

1 Punkt = 1,10 € ohne Mehrwertsteuer

List de prix en points







1 point = 1,10 € hors TVA

Tarifa de precios en puntos

1 punto = 1,10 € IVA excluido

falper.

INDICE / INDEX

	BUTLER SISTEMA GUARDAROBA PER BAGNO <i>Butler bathroom wardrobe system</i> Butler Gardarobesystem für Badezimmer Butler système garde-robe pour salle de bain Butler Sistema vestuario para Baño	Pag. 04 – 08
	DIVISORI CASSETTI <i>Drawer dividers</i> Schubladeneinteiler Séparateurs pour tiroirs Separadores para cajones	Pag. 09 – 12
	ACCESSORI CILINDRO <i>Cilindro accessories</i> Cilindro Zubehör Accessoires Cilindro Opcionales Cilindro	Pag. 13 – 18
	PORTA RUBINETTI <i>Tap holder</i> Armatureträger Porte-Robinets Suporte para grifería	Pag. 19 – 21
	LAVABI DA TERRA <i>Freestanding basins</i> Freistehende Waschbecken Lavabos à colonne Lavabos en columna	Pag. 22 – 24
	SPECCHIO CONTENITORE <i>Mirror cabinets with lighting</i> Spiegelschränke mit Beleuchtung Armoires de toilette avec éclairage Espejos contenedores con luz	Pag. 25 – 28
	CONDIZIONI DI VENDITA <i>Sale conditions</i> Verkaufsbedingungen Conditions de vente Condiciones de venta	Pag. 20 – 30

BUTLER SISTEMA GUARDAROBA PER BAGNO | *Butler bathroom wardrobe system*

Butler Gardarobesystem für Badezimmer | Butler système garde-robe pour salle de bain | Butler sistema vestuario para baño

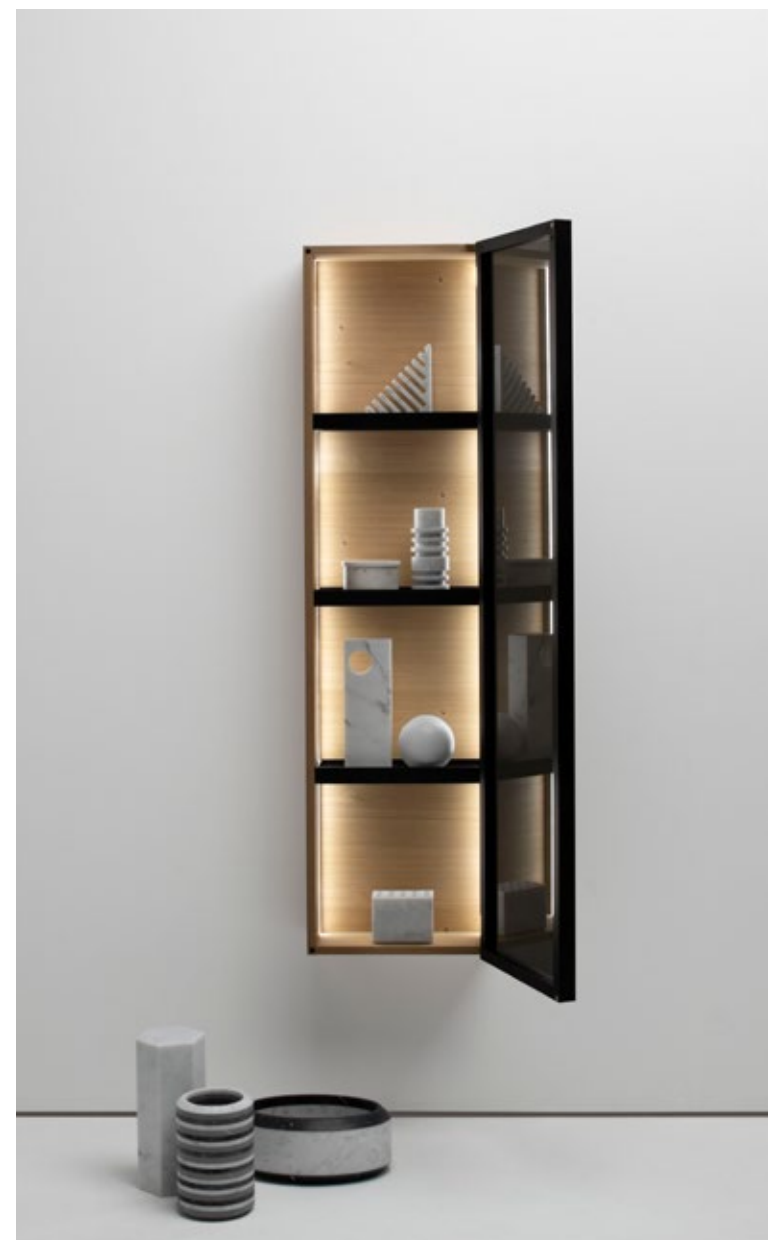

BUTLER SISTEMA GUARDAROBA PER BAGNO | *Butler bathroom wardrobe system*

Butler Gardarobesystem für Badezimmer | Butler système garde-robe pour salle de bain | Butler sistema vestuario para baño

FINITURE | Finishes | Oberfläche | Finitions | Acabados

Cat. 1 / Cat. 3

LACCATI OPACHI E LUCIDI | Matt and glossy painted | Matte und glänzende Lackierung | Lacqué opaque et brillant | Laqueados opacos y brillantes

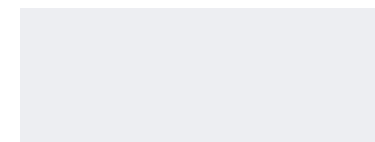

B0 / BL
Bianco
White
Weiß
Blanc
Blanco

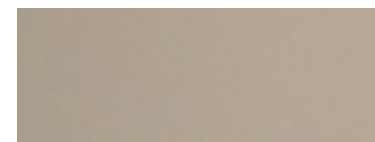

GP / GL
Grigio Pavillon
Pavillon grey
Pavillon Grau
Gris Pavillon
Gris Pavillon



PI / PA
Pioggia
Rain
Regen
Pluie
lluvia



GL / GM
Grigio Londra
London grey
London Grau
Gris Londres
Gris Londres



EY / EZ
Grigio Exclusive
Exclusive grey
Exclusive Grau
Gris Exclusive
Gris Exclusive



GF / GT
Grafite
Graphite
Graphit
Graphite
Grafito

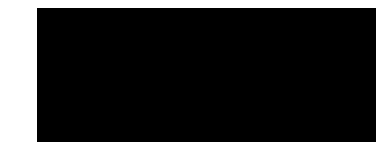

N2 / N1
Nero
Black
Schwarz
Noir
Negro



G5 / G6
Grigio Bromo
Bromo grey
Bromo Grau
Gris Bromo
Gris Bromo



FA / FN
Fango
Mud
Schlamm
Boue
Barro



VI / VN
Visone
Mink
Nerz
Vison
Vison



AZ / A1
Azzurro polvere
Blue powder
Blau Puder
Bleu poudre
Azul pálido



CA / CP
Canapa
Hemp
Hanf
Chanvre
Cañamo



S2 / S1
Sabbia
Sand
Sand
Sable
Arena



C2 / C1
Creta
Clay
Ton
Crête
Creta



C7 / C8
Castoro Ottawa
Ottawa Beaver
Biber-Farbe Ottawa
Castor Ottawa
Castor Ottawa



CD / CL
Argilla
Argilla
Argilla
Argilla
Argilla



FE / FR
Ferro
Iron
Eisen
Fer
Hierro



V1 / V2
Verde Comodoro
Green Commodore
Commodore Grün
Vert Commodore
Verde Comodoro



V7 / V8
Verde Agave
Agave Green
Agave Grau
Vert Agave
Verde Agave



AV / AI
Avio
Aviation
Luftfahrt
Aviation
Aviación



B7 / B8
Blu Fes
Fes blue
Blau Fes
Bleu Fes
Azul Fes

Cat. 2

LEGNI | Woods | Holz | Bois | Maderas



R4
Rovere
Oak
Eiche
Rouvre
Roble



RP
Rovere sbiancato
Bleached oak
Gebleichte Eiche
Rouvre blanchi
Roble blanqueado



RK
Rovere Solid Skin
Solid Skin oak
Eiche "Solid Skin"
Rouvre "Solid Skin"
Roble "Solid Skin"



CG
Canaletto grigio
Grey Canaletto
Canaletto grau
Canaletto gris
Canaletto gris



N8
Noce naturale
Natural walnut
Nussbaum Natur
Noyer naturel
Nogal naturales



NC
Noce Canaletto
Canaletto walnut
Nussbaum Canaletto
Noyer Canaletto
Nogal Canaletto

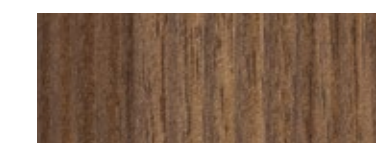

N6
Noce bruciato
Walnut burned
Nussbaum gebrannt
Noyer brûlé
Nogal quemado

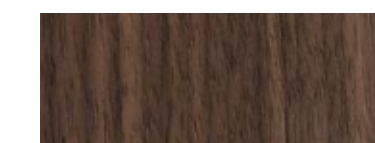

NW
Noce Brown
Walnut Brown
Nussbaum braun
Noyer Foncé
Nogal marrón



RG
Rovere grigio
Grey oak
Eiche grau
Rouvre gris
Roble gris

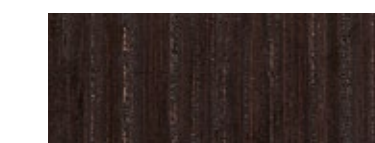

W4
Wengé
Wengé
Wengé
Wengé
Wengué

ANTA | Door | Tür | Porte | Puerta



Alluminio nero opaco
Matt black aluminum
Mattschwarzes Aluminium
Aluminium noir mat
Aluminio negro mate



Vetro dark grey
Dark grey mirror
Dunkelgrauer Spiegel
Miroir gris foncé
Espejo gris oscuro

BUTLER SISTEMA GUARDAROBA PER BAGNO | *Butler bathroom wardrobe system*

Butler Gardarobesystem für Badezimmer | Butler système garde-robe pour salle de bain | Butler sistema vestuario para baño

COLONNA 1 ANTA E RIPIANI IN VETRO | Column with 1 door and glass shelves | Hochschrank mit Tür und Glasablagen | Colonne 1 porte et étagères en verre | Columna con puerta y repisas en vidrio



Versione DX | Right version

Art.	P	L	H
FTA DX • FTB SX	20	40	150

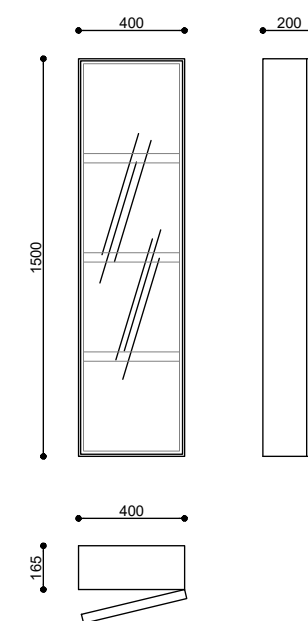

Versione DX | Right version

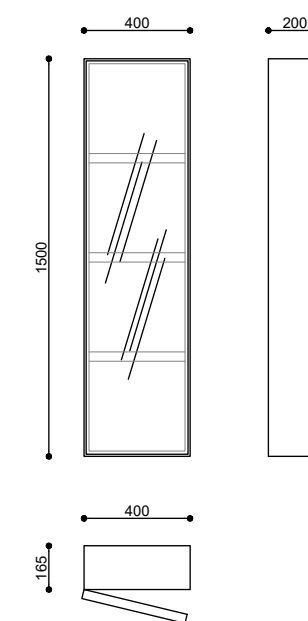

Versione SX | Left version

Cat. 1	Cat. 2	Cat. 3
2.190	2.390	2.290

COLONNA 2 ANTE E RIPIANI IN VETRO | Column with 2 doors and glass shelves | Hochschrank mit 2 Türen und Glasablagen | Colonne 2 portes et étagères en verre | Columna con 2 puertas y repisas en vidrio

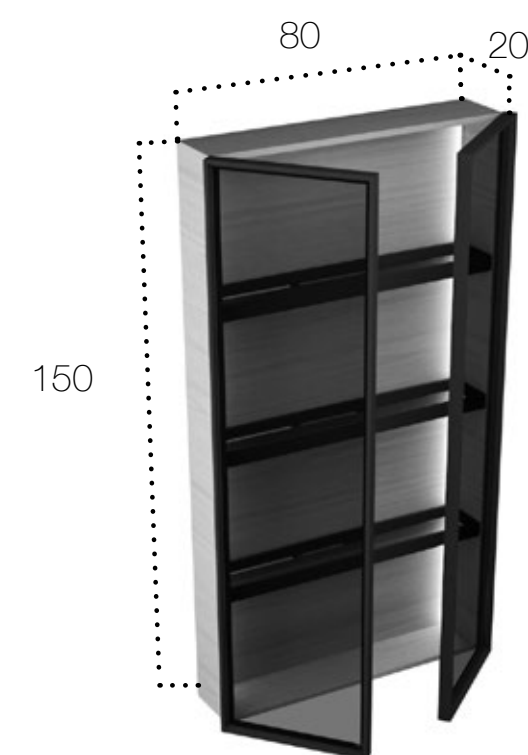

Novità / News 2021.1

Art.	P	L	H
FTC	20	80	150

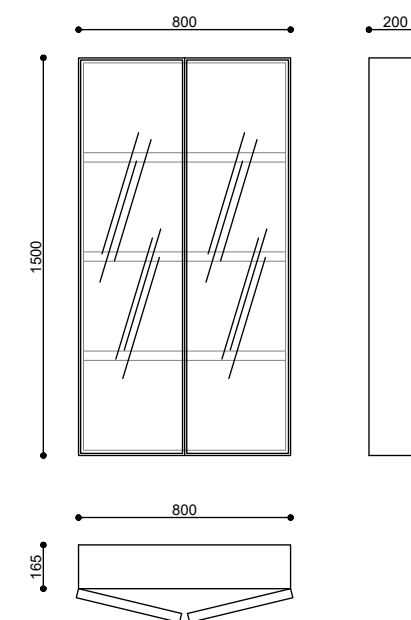

Cat. 1	Cat. 2	Cat. 3
3.290	3.490	3.390

BUTLER SISTEMA GUARDAROBA PER BAGNO | *Butler bathroom wardrobe system*

Butler Gardarobesystem für Badezimmer | Butler système garde-robe pour salle de bain | Butler sistema vestuario para baño

COLONNA 1 ANTA E RIPIANI IN VETRO CON CASSETTI INTERNI | Column with door, glass shelves and internal drawers | Hochschrank mit Tür, Glasablagen und Innenschubladen | Colonne 1 porte et étagères en verre avec tiroirs intérieurs
 Columna con puerta, repisas en vidrio y cajones interiores

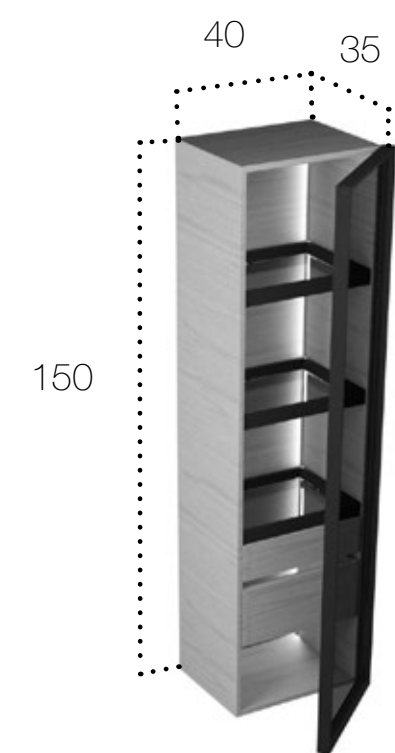

Versione DX | Right version

Art.	P	L	H
FTD DX • FTE SX	35	40	150

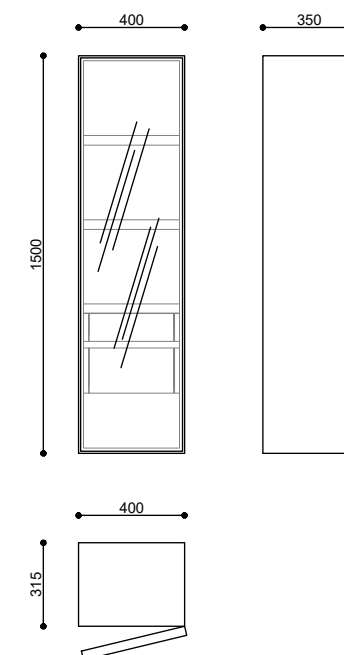

Versione DX | Right version

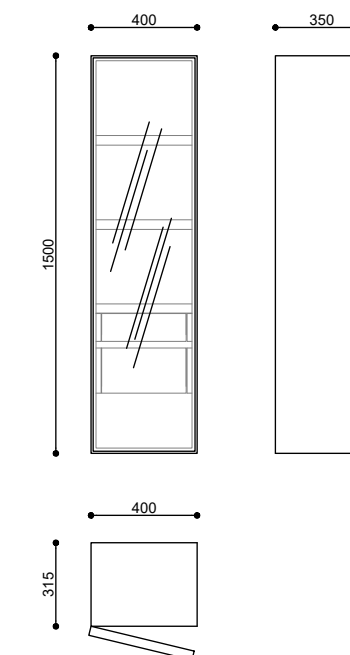

Versione SX | Left version

Cat. 1	Cat. 2	Cat. 3
3.290	3.490	3.390

COLONNA 2 ANTE E RIPIANI IN VETRO CON CASSETTI INTERNI | Column with 2 doors, glass shelves and internal drawers | Hochschrank mit 2 Türen, Glasablagen und Innenschubladen | Colonne 2 portes et étagères en verre avec tiroirs intérieurs
 Columna con 2 puertas, repisas en vidrio y cajones interiores

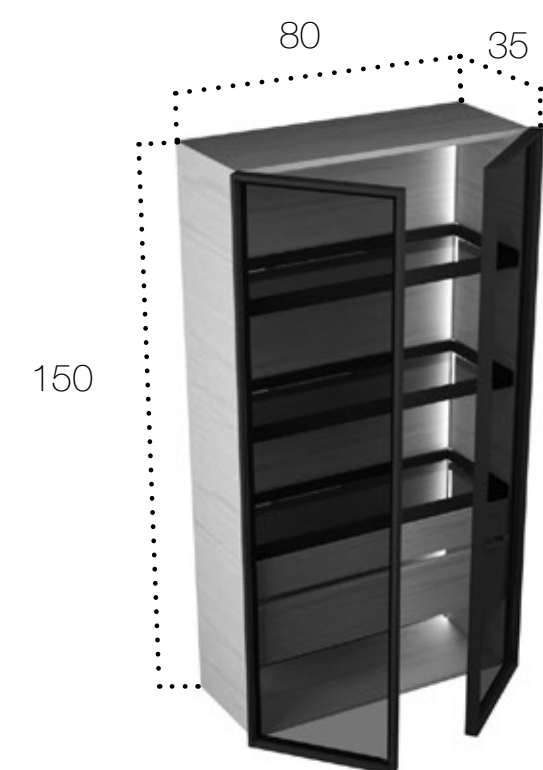

Art.	P	L	H
FTF	35	80	150

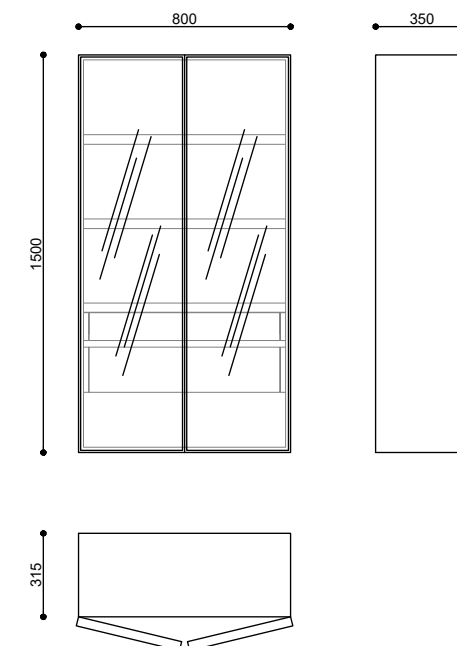

Cat. 1	Cat. 2	Cat. 3
4.980	5.290	5.190

BUTLER SISTEMA GUARDAROBA PER BAGNO | *Butler bathroom wardrobe system*

Butler Gardarobesystem für Badezimmer | Butler système garde-robe pour salle de bain | Butler sistema vestuario para baño

COLONNA 2 ANTE E RIPIANI IN VETRO CON CASSETTI INTERNI | Column with 2 doors, glass shelves and internal drawers | Hochschrank mit 2 Türen, Glasablagen und Innenschubladen | Colonne 2 portes et étagères en verre avec tiroirs intérieurs
Columna con 2 puertas, repisas en vidrio y cajones interiores

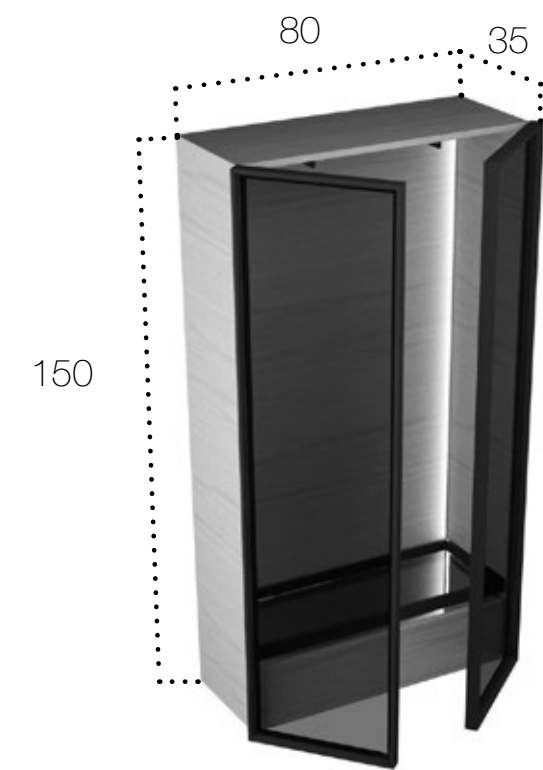

Art.	P	L	H
FTG	35	80	150

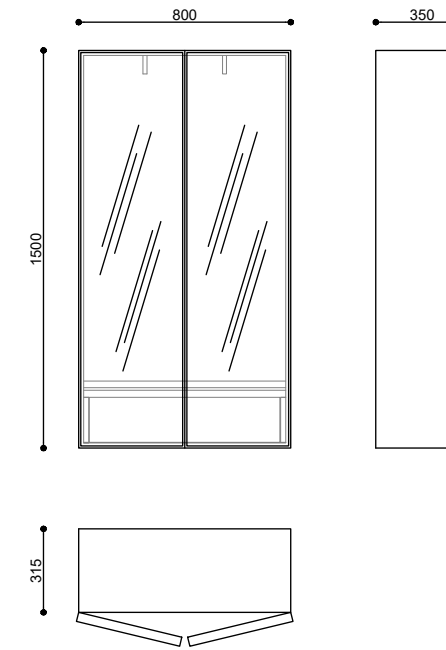

Cat. 1	Cat.2	Cat.3
4.250	4.490	4.390



DIVISORI PER CASSETTI | *Drawer dividers*

Schubladeneinteiler | Séparateurs pour tiroirs | Separadores para cajones

FINITURE | Finishes | Oberfläche | Finitions | Acabados

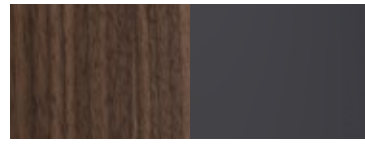

Noce Brown / Grigio

Walnut Brown / Grey
Nussbaum Braun / Grau
Noyer Foncé / Gris
Nogal marrón / Gris



Rovere / Grigio

Oak / Grey
Eiche / Grau
Rouvre / Gris
Roble / Gris

DIVISORI PER CASSETTI | *Drawer dividers*

Schubladeneinteiler | Séparateurs pour tiroirs | Separadores para cajones

CONTENITORI PER CASSETTI SISTEMA BUTLER | Drawer containers for Butler system | Behälter für Schubladen für Butlersystem | Conteneurs pour tiroirs de la colonne Butler | Contenedores para cajones para el sistema Butler



Art.	P	L	H		Noce Brown / Grigio Brown Walnut / Grey	Rovere / Grigio Oak / Grey
FT1	25	15	5	Vassoio	149	149
FT2	25	15	5	Porta oggetti	168	168
FT3	25	15	5	Porta orecchini	210	210
FT4	25	15	5	Porta orologi	258	258
FT5	25	15	5	Porta anelli	258	258

Vassoio
Tray
Tablett
Plateau
Bandeja

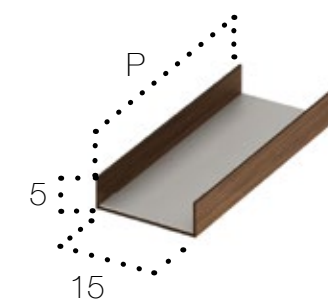

Porta oggetti
Port objects
Handschuhfach
Porte-objet
Guantera

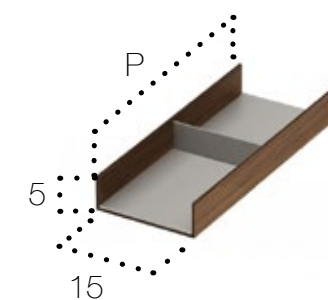

Porta orecchini
Earrings storage
Behälter für Ohringe
Porte-boucles d'oreilles
Contenedor para pendientes

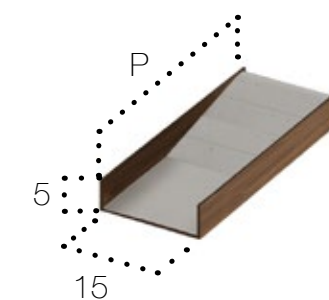

Porta orologi
Watch storage
Behälter für Uhren
Porte-montre
Contenedor para relojes

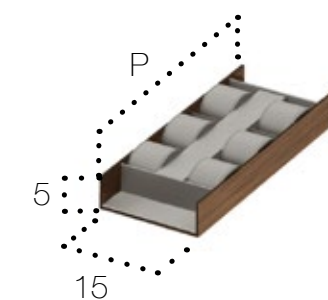

Porta anelli
Ring storage
Behälter für Ringe
Porte-bague
Contenedor para anillos

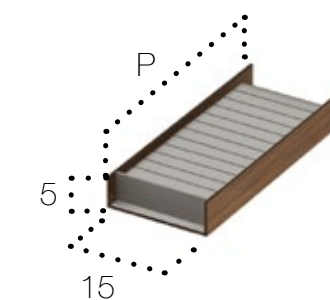

Accessori in laminato compatto di soli 4 mm di spessore impiallacciato noce Canaletto o Rovere. Equipaggiato con una vasta gamma di divisioni interne fatte a mano, realizzate in un'innovativa simil pelle tattile.

Accessories in compact laminate just 4 mm thick with Canaletto walnut veneer or Oak. Equipped with a wide range of handmade internal divisions, made in an innovative tactile leatherette.

Zubehör aus kompaktem Laminat mit einer Dicke von nur 4 mm und Canaletto-Walnussumier oder Eiche. Ausgestattet mit einer großen Auswahl an handgefertigten Innenabteilungen aus innovativem taktilem Kunstleder.

Accessoires en stratifié compact de seulement 4mm d'épaisseur avec placage de Noyer Canaletto ou Rouvre. Équipé d'une large gamme de divisions internes faites à la main, fabriquées dans un innovant similicuir tactile.

Accesorios en laminado compacto de tan solo 4 mm de espesor con chapa de nogal Canaletto o Roble. Equipado con una amplia gama de divisiones internas hechas a mano, realizadas en una innovadora piel sintética táctil.

DIVISORI PER CASSETTI | *Drawer dividers*

Schubladeneinteiler | Séparateurs pour tiroirs | Separadores para cajones

CONTENITORI PER CASSETTI SISTEMA BUTLER | Drawer containers for Butler system | Behälter für Schubladen für Butlersystem | Conteneurs pour tiroirs système Butler | Contenedores para cajones para el sistema Butler



Art.	P	L	H		Noce Brown / Grigio		Rovere / Grigio	
					Brown Walnut / Grey		Oak / Grey	
FX1	32	15	5	Vassoio	149	149	149	149
FX2	32	15	5	Porta oggetti	168	168	168	168
FX3	32	15	5	Porta orecchini	210	210	210	210
FX4	32	15	5	Porta orologi	258	258	258	258
FX5	32	15	5	Porta anelli	258	258	258	258
FX 6	32	15	5	Porta trucchi	258	258	258	258
FY1	37	15	5	Vassoio	149	149	149	149
FY2	37	15	5	Porta oggetti	168	168	168	168
FY3	37	15	5	Porta orecchini	210	210	210	210
FY4	37	15	5	Porta orologi	258	258	258	258
FY5	37	15	5	Porta anelli	258	258	258	258
FY6	37	15	5	Porta trucchi	258	258	258	258

Vassoio
Tray
Tablett
Plateau
Bandeja

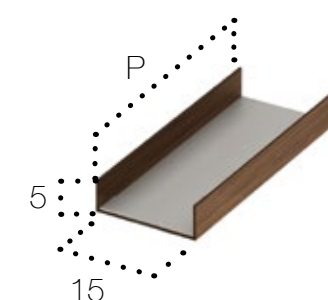

Porta oggetti
Port objects
Handschuhfach
Porte-objet
Guantera

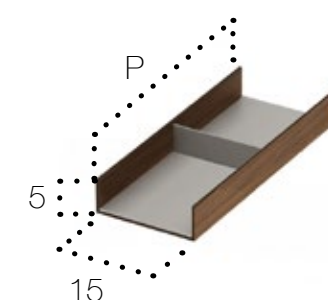

Porta orecchini
Earrings storage
Behälter für Ohrhinge
Porte-boucles d'oreilles
Contenedor para pendientes

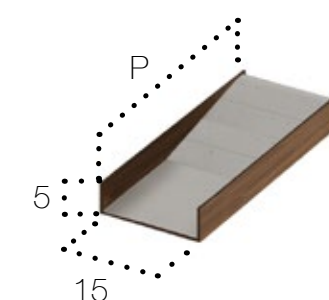

Porta orologi
Watch storage
Behälter für Uhren
Porte-montre
Contenedor para relojes

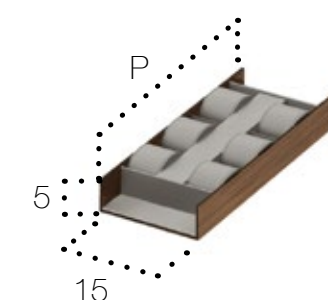

Porta anelli
Ring storage
Behälter für Ringe
Porte-bague
Contenedor para anillos

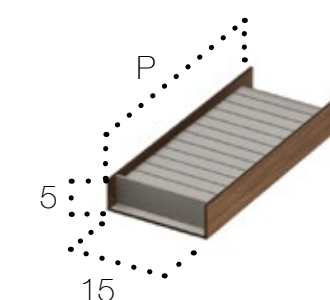

Porta trucchi
Make-up storage
Behälter für Make-up
Porte-Maquillage
Contenedor para maquillaje

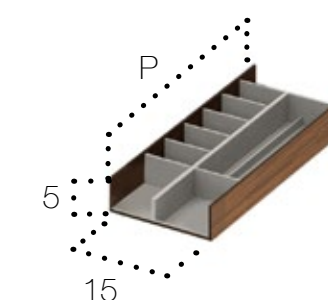

P 32 | Compatibile con mobili profondità 45 cm | Compatible with units depth 45 cm | Kompatibel mit Möbel in Tiefe 45 | Compatible avec meubles avec profondeur 45 cm
Compatibles con mueble de profundidad 45 cm

P 37 | Compatibile con mobili profondità 55 cm | Compatible with units depth 55 cm | Kompatibel mit Möbel in Tiefe 55 | Compatible avec meubles avec profondeur 55 cm
Compatibles con mueble de profundidad 55 cm

Non compatibili con collezione 7.0 | Not Compatible with 7.0 collection | Nicht kompatibel mit Kollektion 7.0 | Non compatibles avec la collection 7.0 | No compatibles con la colección 7.0

Accessori in laminato compatto di soli 4 mm di spessore impiallacciato noce Canaletto o Rovere. Equipaggiato con una vasta gamma di divisioni interne fatte a mano, realizzate in un'innovativa simil pelle tattile.

Accessories in compact laminate just 4 mm thick with Canaletto walnut veneer or Oak. Equipped with a wide range of handmade internal divisions, made in an innovative tactile leatherette.

Zubehör aus kompaktem Laminat mit einer Dicke von nur 4 mm und Canaletto-Walnutfurnier oder Eiche. Ausgestattet mit einer großen Auswahl an handgefertigten Innenabteilungen aus innovativem taktilem Kunstleder.

Accessoires en stratifié compact de seulement 4mm d'épaisseur avec placage de Noyer Canaletto ou Rouvre. Équipé d'une large gamme de divisions internes faites à la main, fabriquées dans un innovant similicuir tactile.

Accesorios en laminado compacto de tan solo 4 mm de espesor con chapa de nogal Canaletto o Roble. Equipado con una amplia gama de divisiones internas hechas a mano, realizadas en una innovadora piel sintética táctil.

ACCESSORI CILINDRO | *Cilindro accessories*

Cilindro Zubehöre | Accessoires Cilindro | Opcionales Cilindro

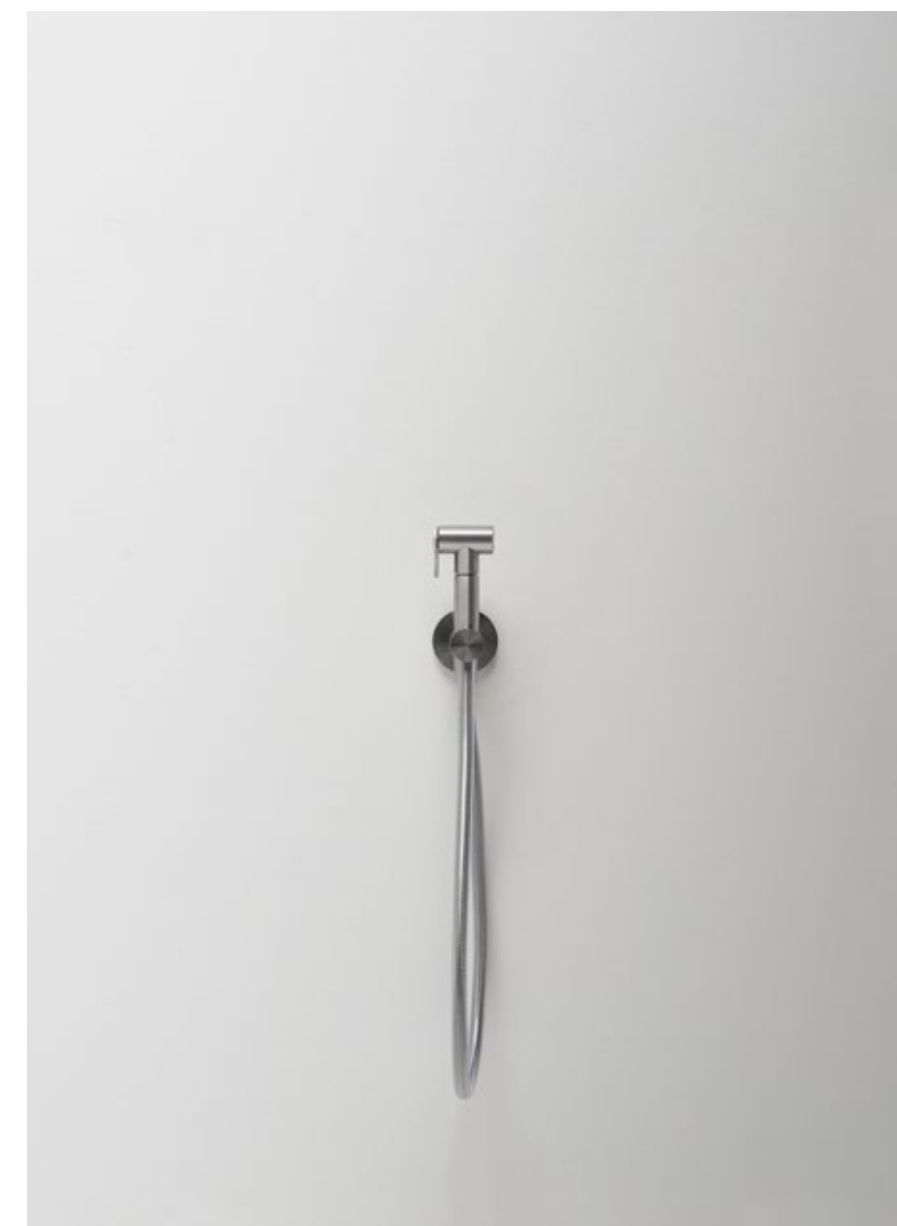
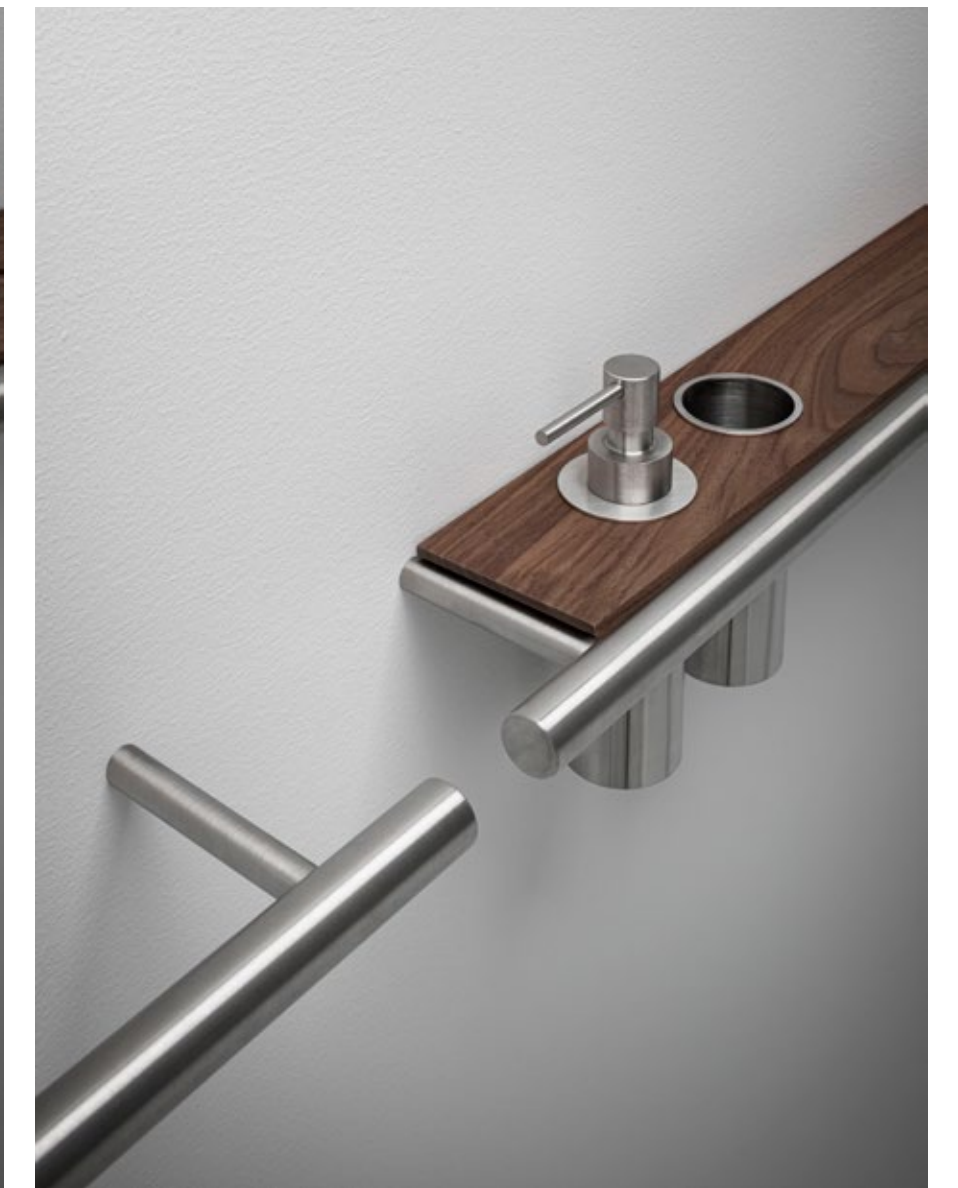
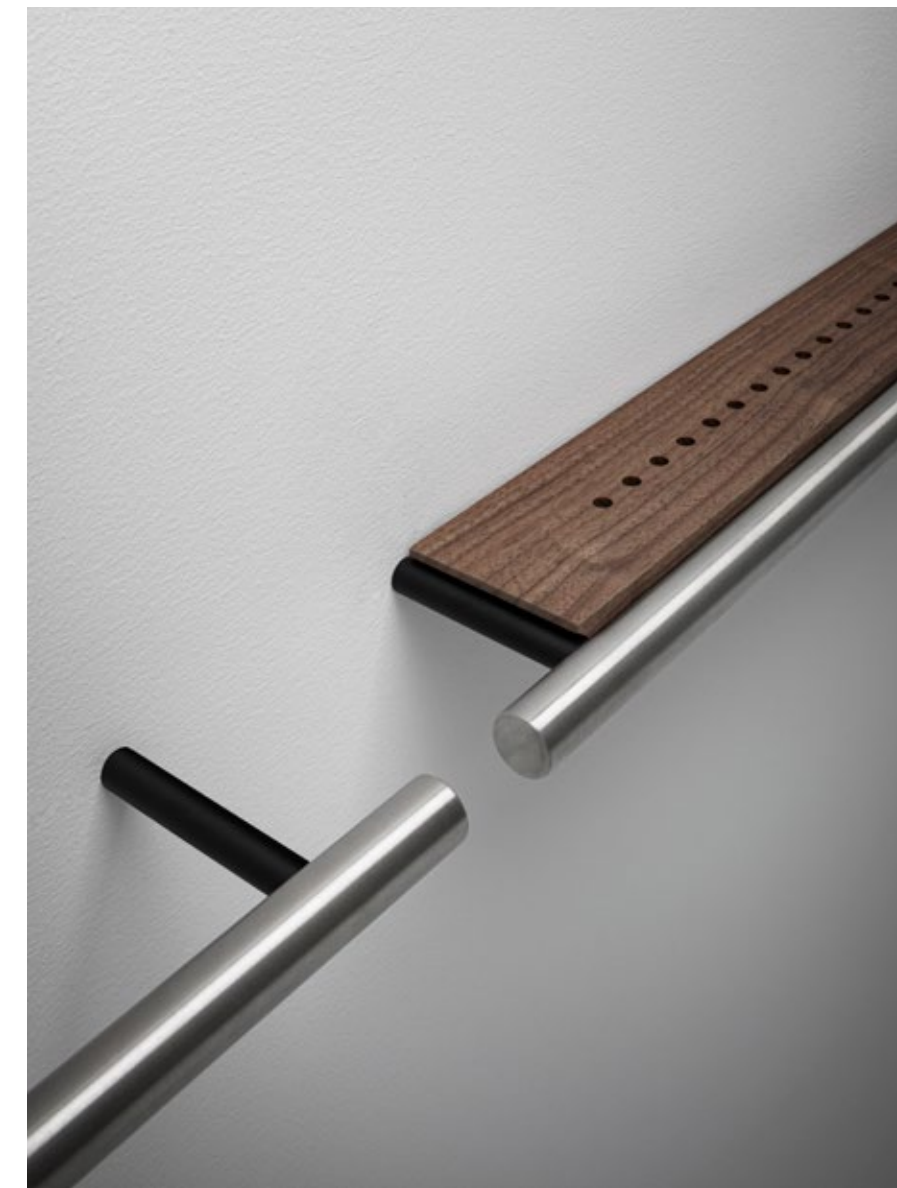

ACCESSORI CILINDRO | *Cilindro accessories*

Cilindro Zubehör | Accessoires Cilindro | Opcionales Cilindro

FINITURE | Finishes | Oberfläche | Finitions | Acabados



SP

Inox spazzolato

Brushed stainless steel
Gebürstetes Edelstahl
Acier inoxydable brossé
Acero inoxidable cepillado



SQ

Inox spazzolato / Nero

Brushed stainless steel/Matt black
Gebürstetes Edelstahl/Schwarz matt
Acier inoxydable brossé/Noir mat
Acero inoxidable cepillado/Negro mate

Cat. 2

LEGNI | Woods | Holz | Bois | Maderas



R4

Rovere

Oak
Eiche
Rouvre
Roble



RP

Rovere sbiancato

Bleached oak
Gebleichte Eiche
Rouvre blanchi
Roble blanqueado



CG

Canaletto grigio

Grey Canaletto
Canaletto Grau
Canaletto gris
Canaletto gris



N8

Noce naturale

Natural walnut
Nussbaum Natur
Noyer naturel
Nogal naturales



NC

Noce Canaletto

Canaletto walnut
Nussbaum Canaletto
Noyer Canaletto
Nogal Canaletto



N6

Noce bruciato

Walnut burned
Nussbaum gebrannt
Noyer brûlé
Nogal quemado

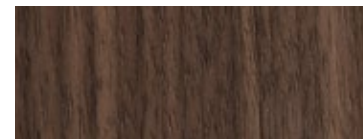

NW

Noce Brown

Walnut Brown
Nussbaum Braun
Noyer Foncé
Nogal marrón



RG

Rovere grigio

Grey oak
Eiche Grau
Rouvre gris
Roble gris



W4

Wengé

Wengé
Wengé
Wengé
Wengé
Wengué

Cristalplant Biobased



00

Bianco opaco

Matt white
Weiss matt
Blanc mat
Blanco mate

ACCESSORI CILINDRO | *Cilindro accessories*

Cilindro Zubehöre | Accessoires Cilindro | Opcionales Cilindro

PORTA SALVIETTE A PARETE DECENTRATO | Off-centred wall towel bar | Dezentralisierter Wandhandtuchhalter | Porte-serviette au mur décentralisé | Toallero a pared descentralizado



Versione DX | Right version

Art.	P	L
GX5 DX • GX6 SX	10,4	60

Materiale: Acciaio Inox | Material: Steel
Material: Stahl | Matériau: Acier | Material: Acero

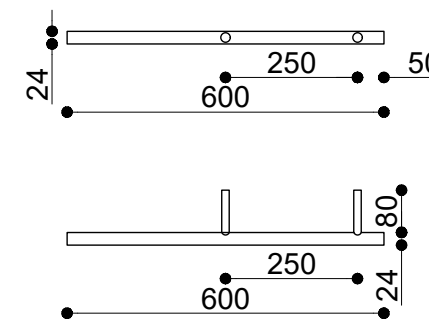

Inox spazzolato
Brushed stainless steel
284

Inox spazzolato/nero opaco
Brushed stainless steel/matt black
294

MENSOLA PER PORTA SALVIETTE A PARETE DECENTRATO | Shelf for off-centred wall towel bar | Ablage für dezentralisierten Wandhandtuchhalter | Étagère porte-serviette au mur décentralisée | Repisa para toallero a pared descentralizado



Art.	P	L
GY7	7,8	25
GY8	7,8	25

Mensola in massello di Noce o Rovere o Cristalplant | Shelf in solid walnut, solid oak or Cristalplant | Ablage aus Massivnussbaum, Massiveiche oder Cristalplant | Étagère en bois massif de noyer ou rouvre ou Cristalplant | Repisa en nogal macizo, roble macizo o cristalplant

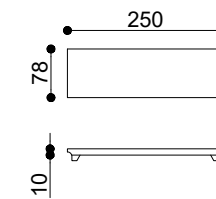

Cat. 2 **Cristalplant**
113 **69**

MENSOLA CON DOSATORE SAPONE E BICCHIERE PER PORTA SALVIETTE A PARETE DECENTRATO | Shelf with soap dispenser and glass for off-centred wall towel bar | Ablage mit Seifenspender und Glas für dezentralisierten Wandhandtuchhalter | Étagère avec distributeur savon et verre pour porte-serviette au mur décentralisée | Repisa con jabonera y vaso para toallero a pared descentralizado



Art.	P	L
#B01	7,8	25
#B02	7,8	25

Mensola in massello di Noce o Rovere o Cristalplant | Shelf in solid walnut, solid oak or Cristalplant | Ablage aus Massivnussbaum, Massiveiche oder Cristalplant | Étagère en bois massif de noyer ou rouvre ou Cristalplant | Repisa en nogal macizo, roble macizo o cristalplant

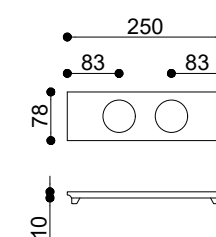

Cat. 2 **Cristalplant**
429 **390**

COMPOSIZIONI | Compositions | Zusammensetzung | Compositions | Composicion

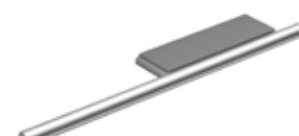

ACCESSORI CILINDRO | *Cilindro accessories*

Cilindro Zubehöre | Accessoires Cilindro | Opcionales Cilindro

PORTA SALVIETTE A PARETE | Wall towel bar | Wandhandtuchhalter | Porte-serviette au mur | Toallero a pared



Art.	P	L
GX3	10,4	60

Materiale: Acciaio Inox | Material: Steel
Material: Stahl | Matériau: Acier | Material: Acero

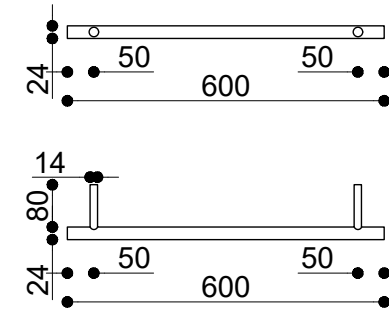

Inox spazzolato
Brushed stainless steel
284

Inox spazzolato/nero opaco
Brushed stainless steel/matt black
294

MENSOLA PER PORTA SALVIETTE A PARETE | Shelf for wall towel bar | Ablage für Wandhandtuchhalter | Étagère porte-serviette au mur | Repisa para toallero a pared



Art.	P	L
GY5	7,8	50
GY6	7,8	50

Mensola in massello di Noce o Rovere o Cristalplant | Shelf in solid walnut, solid oak or Cristalplant | Ablage aus Massivnussbaum, Massiveiche oder Cristalplant | Étagère en bois massif de noyer ou rouvre ou Cristalplant | Repisa en nogal macizo, roble macizo o cristalplant

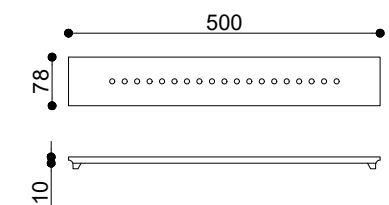

Cat. 2 **Cristalplant**
170 **98**

MENSOLA CON DOSATORE SAPONE E BICCHIERE PER PORTA SALVIETTE A PARETE | Shelf with soap dispenser and glass for wall towel bar | Ablage mit Seifenspender und Glas für Wandhandtuchhalter | Étagère avec distributeur savon et verre pour porte-serviette au mur | Repisa con jabonera y vaso para toallero a pared



Art.	P	L
#B03 DX • #B04 SX	7,8	50
#B05 DX • #B06 SX	7,8	50

Mensola in massello di Noce o Rovere o Cristalplant | Shelf in solid walnut, solid oak or Cristalplant | Ablage aus Massivnussbaum, Massiveiche oder Cristalplant | Étagère en bois massif de noyer ou rouvre ou Cristalplant | Repisa en nogal macizo, roble macizo o cristalplant

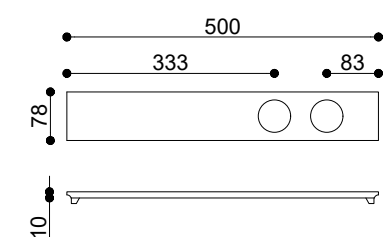

Cat. 2 **Cristalplant**
486 **425**

COMPOSIZIONI | Compositions | Zusammensetzung | Compositions | Composicion

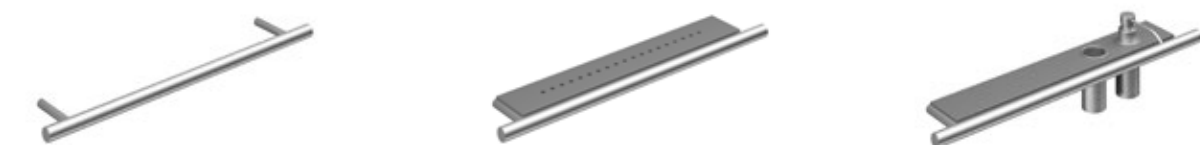

ACCESSORI CILINDRO | *Cilindro accessories*

Cilindro Zubehöre | Accessoires Cilindro | Opcionales Cilindro

PORTA SALVIETTE FREESTANDING | Freestanding towel holder | Freistehender Tuchhalter | Porte-serviette sur pied | Toallero en columna



Art.	P	L	H
GX1	22	75	70

Materiale: Acciaio Inox | Material: Steel
Material: Stahl | Matériau: Acier | Material: Acero

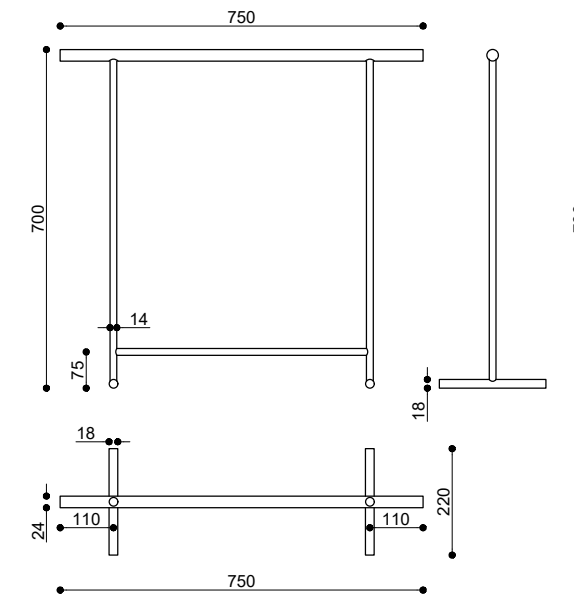

Inox spazzolato
Brushed stainless steel
499

Inox spazzolato/nero opaco
Brushed stainless steel/matt black
520

PIASTRINA ACCIAIO PER PARETI MORBIDE | Steel plate for soft walls | Stahlplatte für weiche Wände | Assiette en acier pour mur souple | Placa de acero para paredes blandas



Art.	P	L	H
GZ8	2	2	0,3

Materiale: Acciaio Inox | Material: Steel
Material: Stahl | Matériau: Acier | Material: Acero

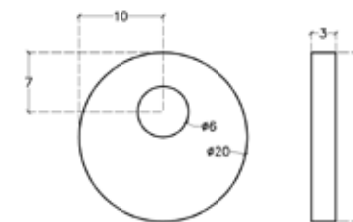

Inox spazzolato
Brushed stainless steel
35*

Inox spazzolato/nero opaco
Brushed stainless steel/matt black
35*

* Prezzo per singolo articolo | Price for single item

IDROSCOPINO | Hydrobrush | Hydrobrush | Hydro-brosse de toilette | Escobillero con chorro de agua



Art.	P	L	H
GZ7	8,2	6,3	15,4

Materiale: Acciaio Inox | Material: Steel
Material: Stahl | Matériau: Acier | Material: Acero

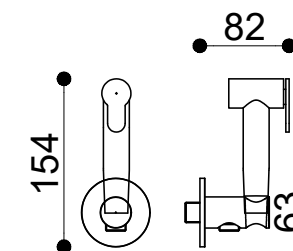

Inox spazzolato/nero opaco
Brushed stainless steel/matt black
590

ACCESSORI CILINDRO | *Cilindro accessories*

Cilindro Zubehöre | Accessoires Cilindro | Opcionales Cilindro

PORTA ROTOLO DA TERRA | Floorstanding toilet paper holder | Bodentoilettenpapierhalter | Porte-rouleau de papier toilette | Suporte de papel higiénico en columna



Art.	P	L	H
GZ6	9	9	55

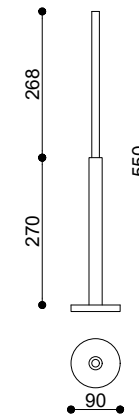

Materiale: Acciaio Inox | Material: Steel
Material: Stahl | Matériau: Acier | Material: Acero

Inox spazzolato
Brushed stainless steel
229

Inox spazzolato/nero opaco
Brushed stainless steel/matt black
230

PORTA SCOPINO DA TERRA | Floorstanding toilet brush holder | Bodenklobürste | Porte-brosse de toilette au sol | Escobillero en columna



Art.	P	L	H
GZ3	6,4	6,4	55

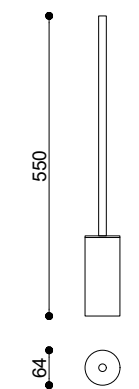

Materiale: Acciaio Inox | Material: Steel
Material: Stahl | Matériau: Acier | Material: Acero

Inox spazzolato
Brushed stainless steel
189

Inox spazzolato/nero opaco
Brushed stainless steel/matt black
199

PORTA SCOPINO DA TERRA | Floorstanding toilet brush holder | Bodenklobürste | Porte-brosse de toilette au sol | Escobillero en columna



Art.	P	L	H
GZ4	6,4	8,6	55

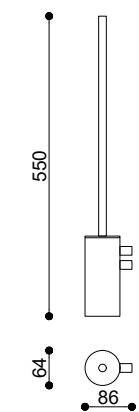

Materiale: Acciaio Inox | Material: Steel
Material: Stahl | Matériau: Acier | Material: Acero

Inox spazzolato
Brushed stainless steel
239

Inox spazzolato/nero opaco
Brushed stainless steel/matt black
249



PORTA RUBINETTI CILINDRO | *Cilindro tap holder*

Armaturenhalter | porte-robinets Cilindro | Suportes para griferia

FINITURE | Finishes | Oberfläche | Finitions | Acabados







Cat. 1

LACCATI OPACHI | Matt painted | Matte Lackierung | Lacqué opaque | Laqueados opacos

										
B0 Bianco White Weiß Blanc Blanco	GP Grigio Pavillon Pavillon grey Pavillon Grau Gris Pavillon Gris Pavillon	PI Pioggia Rain Regen Pluie lluvia	GL Grigio Londra London grey London Grau Gris Londres Gris Londres	EY Grigio Exclusive Exclusive grey Exclusive Grau Gris Exclusive Gris Exclusive	GF Grafite Graphite Graphit Graphite Grafito	N2 Nero Black Schwarz Noir Negro	G5 Grigio Bromo Bromo grey Bromo Grau Gris Bromo Gris Bromo	FA Fango Mud Schlamm Boue Barro	VI Visone Mink Nerz Vison Vison	AZ Azzurro polvere Blue powder Blau Puder Bleu poudre Azul pálido
										
CA Canapa Hemp Hanf Chanvre Cañamo	S2 Sabbia Sand Sand Sable Arena	C2 Creta Clay Ton Crête Creta	C7 Castoro Ottawa Ottawa Beaver Biber-Farbe Ottawa Castor Ottawa Castor Ottawa	CD Argilla Argilla Argilla Argilla Argilla	FE Ferro Iron Eisen Fer Hierro	V1 Verde Commodore Green Commodore Commodore Grün Vert Commodore Verde Commodore	V7 Verde Agave Agave Green Agave Grün Vert Agave Verde Agave	AV Avio Aviation Luftfahrt Aviation Aviación	B7 Blu Fes Fes blue Blau Fes Bleu Fes Azul Fes	

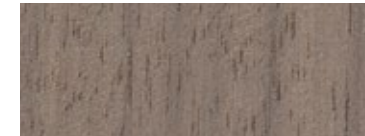
Cat. 2

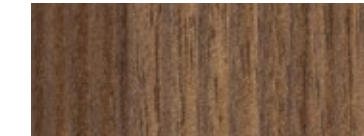
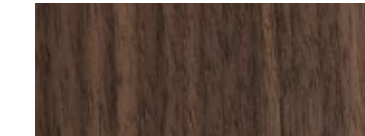
LEGNI | Woods | Holz | Bois | Maderas

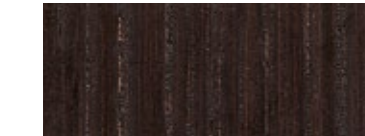
									
R4 Rovere Oak Eiche Rouvre Roble	RP Rovere sbiancato Bleached oak Gebleichte Eiche Rouvre blanchi Roble blanqueado	RK Rovere Solid Skin Solid Skin oak Eiche "Solid Skin" Rouvre "Solid Skin" Roble "Solid Skin"	CG Canaletto grigio Grey Canaletto Canaletto Grau Canaletto gris Canaletto gris	N8 Noce naturale Natural walnut Nussbaum Natur Noyer naturel Nogal naturales	NC Noce Canaletto Canaletto walnut Nussbaum Canaletto Noyer Canaletto Nogal Canaletto	N6 Noce bruciato Walnut burned Nussbaum gebrannt Noyer brûlé Nogal quemado	NW Noce Brown Walnut Brown Nussbaum Braun Noyer Foncé Nogal marrón	RG Rovere grigio Grey oak Eiche Grau Rouvre gris Roble gris	W4 Wengé Wengé Wengé Wengé Wengé

PORTA SALVIETTE IN ACCIAIO | Inox steel towel holder | Edelstahlhandtuchhalter | Porte-serviette en acier | Toallero en acero



SP
Inox spazzolato
Brushed stainless steel
Gebürstetes Edelstahl
Acier inoxydable brossé
Acero inoxidable cepillado

PORTA RUBINETTI CILINDRO | *Cilindro tap holder*

Armaturenhalter | porte-robinets Cilindro | Suportes para griferia

PORTA RUBINETTO A PARETE CON PORTA SALVIETTE PER LAVABO FREESTANDING | Wall tap holder with towel bar for freestanding basin | Hahnwandhalter mit Tuchhalter für freistehendes Becken | Porte-robinet au mur avec porte-serviette pour lavabo sur pied | Suporte para grifo a pared con toallero para lavabo en columna



Versione DX | Right version

Art.	P	L	H
GX7 DX • GX8 SX	7,8	60	93

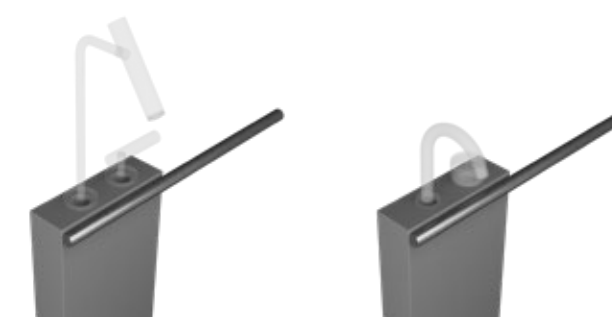
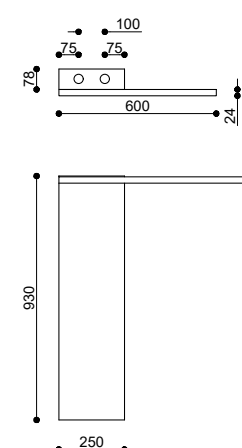

Porta rubinetteria compatibile con serie acquifero e cilindro | Tap holder compatible with acquifero and cilindro taps | Hahnhalter kompatibel mit acquifero- und cilindroarmaturen | Porte-robinets compatible avec les séries acquifero et cilindro | Suporte para griferia compatible con grifos acquifero y cilindro

Cat.1	Cat.2
749	829

PORTA RUBINETTO A PAVIMENTO CON PORTA SALVIETTE PER VASCA | Floor standing tap holder with towel bar for bathtub | Bodenstehender Hahnhalter mit Tuchhalter für Badewanne | Porte-robinet au sol avec porte-serviette pour baignoire | Suporte para grifo en columna con toallero para bañera



Versione DX | Right version

Art.	P	L	H
GZ1 DX • GZ2 SX	7,8	80	56

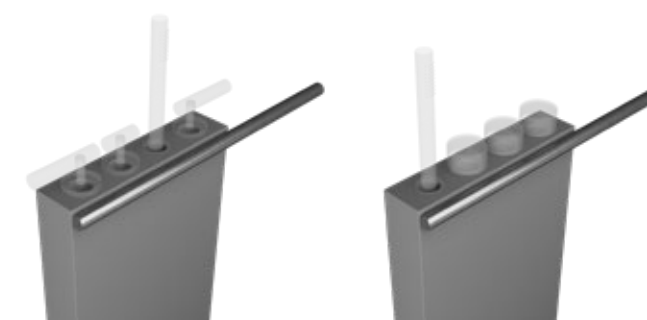
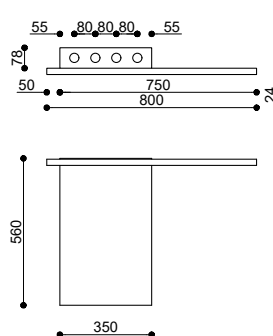

Porta rubinetteria compatibile con serie acquifero e cilindro | Tap holder compatible with acquifero and cilindro taps | Hahnhalter kompatibel mit acquifero- und cilindroarmaturen | Porte-robinets compatible avec les séries acquifero et cilindro | Suporte para griferia compatible con grifos acquifero y cilindro

Cat.1	Cat.2
839	939

OPTIONAL RUBINETTO D'ARRESTO | Optional shut-off valve | Option Absperrhahn | Option vanne d'arrêt | Opcional valvula cierre

Art.

GXS

Materiale: Acciaio Inox | Material: Steel
Material: Stahl | Matériau: Acier | Material: Acero

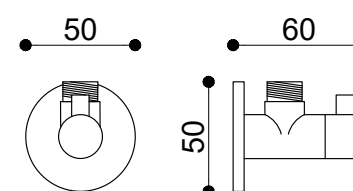

179

FONTANA LAVABO DA TERRA | Fontana *freestanding basin*
Fontana freistehendes Waschbecken | Fontana lavabo à colonne | Fontana lavabo en columna



FONTANA LAVABO DA TERRA | Fontana *freestanding basin*

Fontana freistehendes Waschbecken | Fontana lavabo à colonne | Fontana lavabo en columna

FINITURE | Finishes | Oberfläche | Finitions | Acabados

Cristalplant Biobased



00

Bianco opaco

Matt white

Weiss matt

Blanc mat

Blanco mate

FONTANA LAVABO DA TERRA | Fontana *freestanding basin*
Fontana freistehendes Waschbecken | Fontana lavabo à colonne | Fontana lavabo en columna

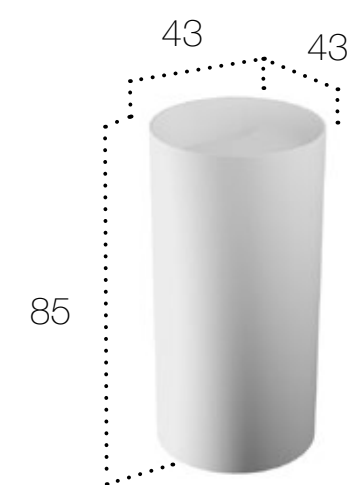

P	L	H
43	43	85

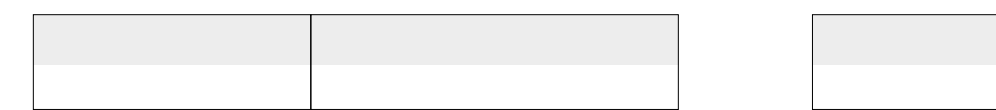
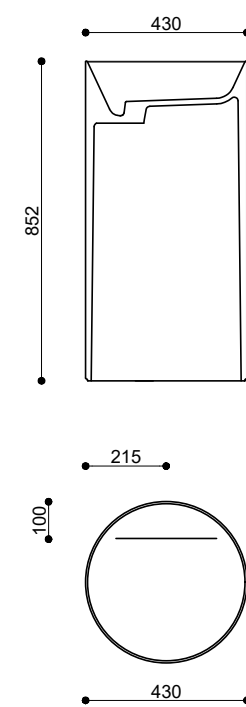

PASSEPARTOUT PER RACCORDO SIFONE | Passepartout for waste joint siphons | Passepartout für Anschluss an Geruchverschluss | Passepartout pour raccord à siphon | Passepartout para roscar a sifón

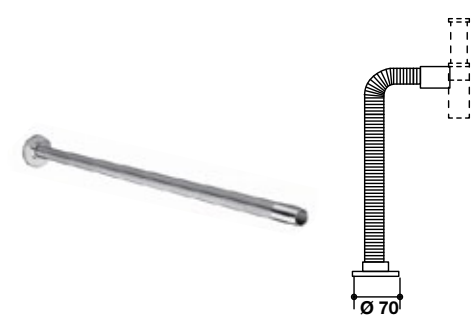

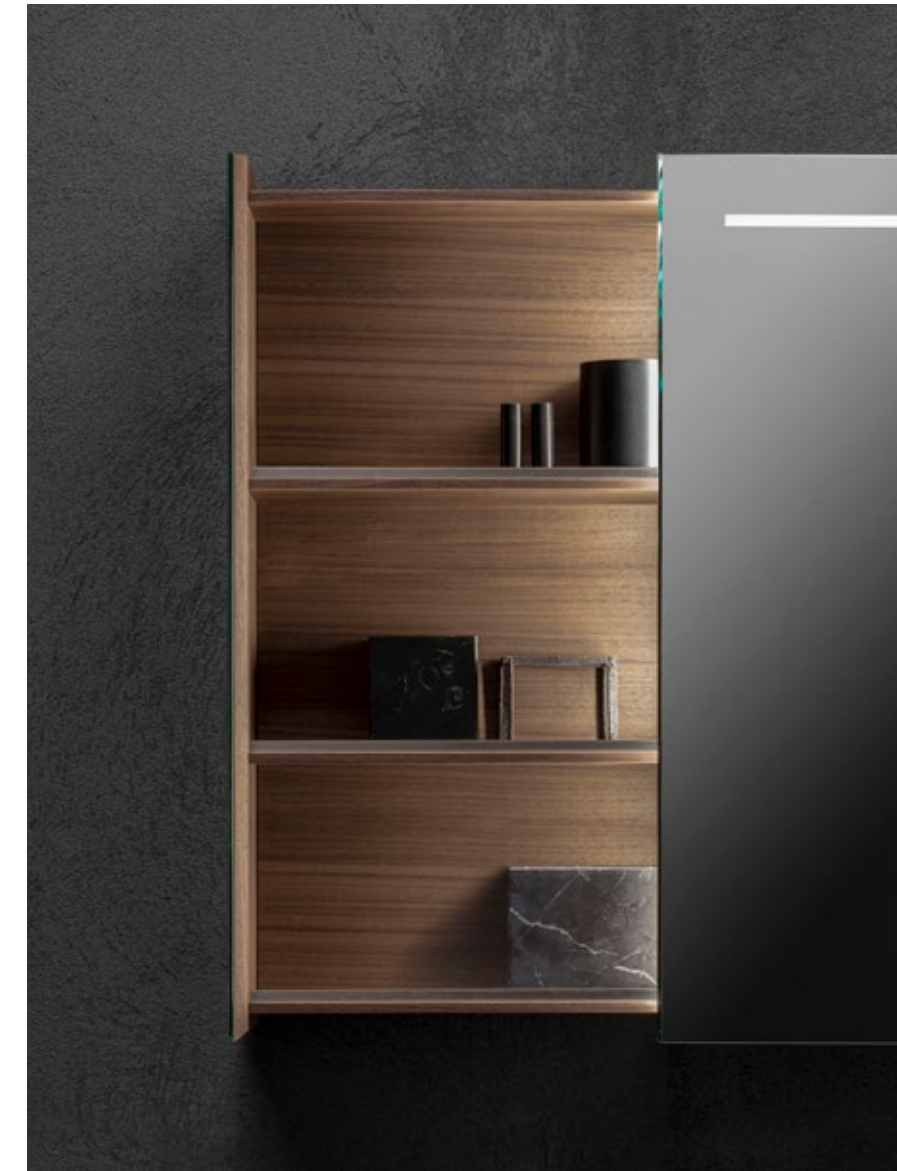

SPECCHI CONTENITORI CON VANO ESTRAIBILE E ILLUMINAZIONE | *Mirror cabinets with lighting*

Spiegelschränke mit Beleuchtung | Armoires de toilette avec éclairage | Espejos contenedores con luz

FINITURE | Finishes | Oberfläche | Finitions | Acabados









Cat. 1

LACCATI OPACHI | Matt painted | Matte Lackierung | Lacqué opaque | Laqueados opacos

										
B0 Bianco White Weiß Blanc Blanco	GP Grigio Pavillon Pavillon grey Pavillon Grau Gris Pavillon Gris Pavillon	PI Pioggia Rain Regen Pluie lluvia	GL Grigio Londra London grey London Grau Gris Londres Gris Londres	EY Grigio Exclusive Exclusive grey Exclusive Grau Gris Exclusive Gris Exclusive	GF Grafite Graphite Graphit Graphite Grafito	N2 Nero Black Schwarz Noir Negro	G5 Grigio Bromo Bromo grey Bromo Grau Gris Bromo Gris Bromo	FA Fango Mud Schlamm Boue Barro	VI Visone Mink Nerz Vison Vison	AZ Azzurro polvere Blue powder Blau Puder Bleu poudre Azul pálido
										
CA Canapa Hemp Hanf Chanvre Cañamo	S2 Sabbia Sand Sand Sable Arena	C2 Creta Clay Ton Crête Creta	C7 Castoro Ottawa Ottawa Beaver Biber-Farbe Ottawa Castor Ottawa Castor Ottawa	CD Argilla Argilla Argilla Argilla Argilla	FE Ferro Iron Eisen Fer Hierro	V1 Verde Commodore Green Commodore Commodore Grün Vert Commodore Verde Commodore	V7 Verde Agave Agave Green Agave Grün Vert Agave Verde Agave	AV Avio Aviation Luftfahrt Aviation Aviación	B7 Blu Fes Fes blue Blau Fes Bleu Fes Azul Fes	

Cat. 2

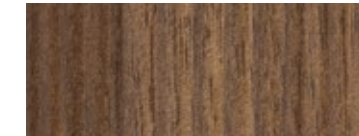
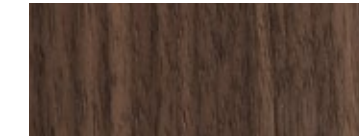
LEGNI | Woods | Holz | Bois | Maderas

									
R4 Rovere Oak Eiche Rouvre Roble	RP Rovere sbiancato Bleached oak Gebleichte Eiche Rouvre blanchi Roble blanqueado	RK Rovere Solid Skin Solid Skin oak Eiche "Solid Skin" Rouvre "Solid Skin" Roble "Solid Skin"	CG Canaletto grigio Grey Canaletto Canaletto Grau Canaletto gris Canaletto gris	N8 Noce naturale Natural walnut Nussbaum Natur Noyer naturel Nogal naturales	NC Noce Canaletto Canaletto walnut Nussbaum Canaletto Noyer Canaletto Nogal Canaletto	N6 Noce bruciato Walnut burned Nussbaum gebrannt Noyer brûlé Nogal quemado	NW Noce Brown Walnut Brown Nussbaum Braun Noyer Foncé Nogal marrón	RG Rovere grigio Grey oak Eiche Grau Rouvre gris Roble gris	W4 Wengé Wengé Wengé Wengé Wengé

SPECCHI CONTENITORI CON VANO ESTRAIBILE E ILLUMINAZIONE | *Mirror cabinets with lighting*

Spiegelschränke mit Beleuchtung | Armoires de toilette avec éclairage | Espejos contenedores con luz

SPECCHI CONTENITORI CON ILLUMINAZIONE INTERNA E VANO ESTRAIBILE LATERALE | Cabinet mirror with internal lighting and pull-out compartment | Spiegelschränke mit interner Beleuchtung und ausziehbarem Fach | Armoire de toilette avec 'éclairage intérieur et compartiment extractible | Espejos contenedores con luz interior y compartimento extraíbles

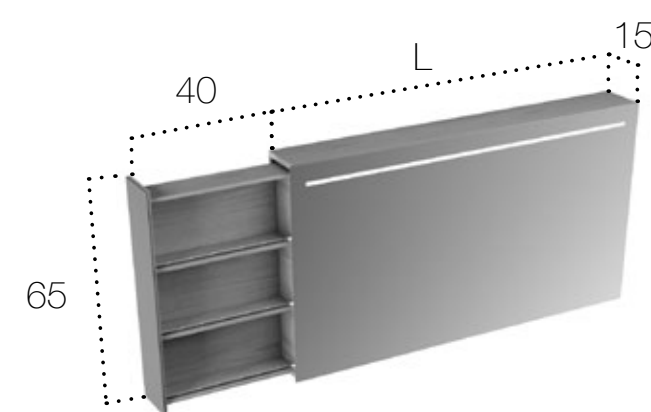

Versione SX | Left version

Art.	P	L	H
ZPA 80 DX • ZPB 80 SX	15	80	65
ZPA 100 DX • ZPB 100 SX	15	100	65
ZPA 120 DX • ZPB 120 SX	15	120	65

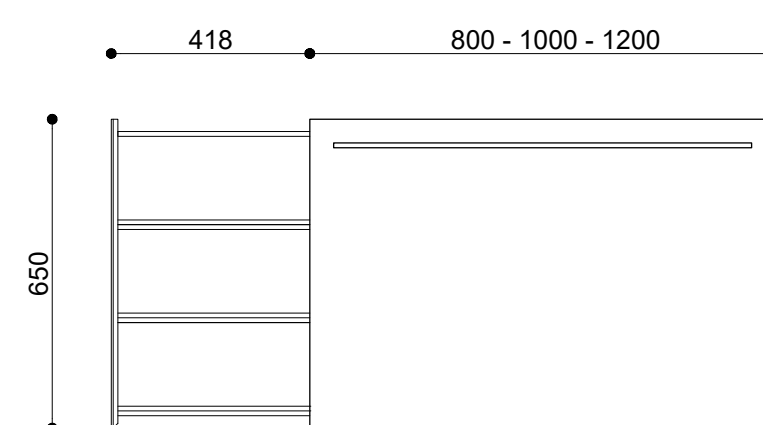

Versione SX | Left version

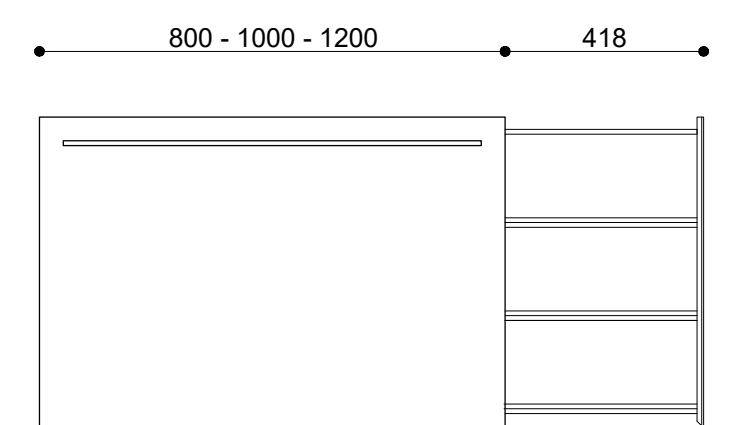

Versione DX | Right version

Cat.1	Cat.2
1.920	2.090
1.990	2.180
2.090	2.280

OPTIONAL PRESA ELETTRICA + 2 PRESE USB CON CABLAGGIO | Optional electrical outlet + 2 usb sockets with wiring | Optional Stromsteckdose + Usb-Anschlüsse mit Verkabelung | Option prise électrique + 2 prise usb avec câblage Opcional enchufe eléctrico + 2 tomas usb con cableado



Art.

Q83 DX • Q84 SX
Q86 DX • Q87 SX

Con presa elettrica svizzera | CH outlet
Mit CH Stromsteckdose | Avec prise électrique
Suisse | Opcional enchufe eléctrico suizo

Cad. / Each **394**
Cad. / Each **394**

OPTIONAL DOPPIA PRESA ELETTRICA CON CABLAGGIO | Optional two electrical outlet with wiring | Optional Doppelstromsteckdose mit Verkabelung | Option doble prise électrique avec câblage | Opcional doble enchufe eléctrico con cableado



Art.

Q81 DX • Q82 SX
Q93 DX • Q94 SX

Con presa elettrica svizzera | CH outlet
Mit CH Stromsteckdose | Avec prise électrique
Suisse | Opcional enchufe eléctrico suizo

Cad. / Each **294**
Cad. / Each **294**

- I prezzi si intendono Iva esclusa, franco ns/Stabilimento.
 - I termini previsti per l'approntamento e la consegna non sono da intendere come essenziali e saranno indicati nell'Accettazione d'Ordine; sono in ogni caso fatti salvi i ritardi sui quali abbiano influito cause di forza maggiore o, comunque cause non pienamente imputabili alla Venditrice. È convenuto, comunque, che nessun ritardo potrà dar diritto al Compratore a risarcimento danni o a risoluzioni del contratto. La consegna dei prodotti potrà anche avvenire mediante consegne successive parziali.
 - La merce viaggia sempre a rischio e pericolo dell'acquirente anche se venduta franco destino. L'acquirente è tenuto a controllare la merce in arrivo contestando eventuali danni o manomissioni degli imballi al momento dello scarico, indicando "l'accettazione con riserva" sul documento di trasporto e comunicando alla Falper l'entità degli eventuali danni entro 8 giorni a mezzo lettera raccomandata.
 - Non saranno evasi ordini inferiori a € 105,00 netti, che verranno comunque tenuti in considerazione in attesa di eventuali aggiunte. Da quanto sopra restano esclusi eventuali pezzi di ricambio.
 - L'eventuale resa della merce sarà accettata solo se preventivamente autorizzata dalla ns/Direzione e dovrà comunque pervenire in Porto Franco ai ns/Stabilimenti di Ozzano. In ogni caso i resi saranno gravati del 20% per spese generali, oltre ad eventuali altre spese dovute all'incuria del Cliente.
 - Particolari imballi in legno o pallets eventualmente necessari saranno fatturati al costo.
 - La FALPER si riserva il diritto di apportare ai propri modelli le modifiche tecniche ed estetiche che si rendessero necessarie senza preavviso alcuno.
 - Per qualsiasi controversia relativa al presente accordo fra le Parti e/o ai singoli contratti di compravendita, è esclusivamente competente il foro di Bologna rinunciando espressamente il Compratore alla competenza di altri Fori, anche a titolo di connessione.
 - Le suddette condizioni si intendono accettate integralmente contestualmente al ricevimento dell'ordine.
-
- Prices are intended Iva Excluded, free our factory.
 - Foreseen terms for the production and the delivery are not to be intended as essential and will be indicated in the order acceptance; the delays owing to a cause beyond control or to a cause not entirely imputable to the seller, are to be considered safe. It was agreed anyway, that any delay will not give to the buyer the right of asking for a compensation for damages or for cancellation of a contract. The goods delivery could take place through partial subsequent deliveries.
 - Although delivery is free of charge, goods are despatched at the risk of the buyer. the buyer must check the goods on arrival and any packaging damage or tampering must be reported at the time they are unloaded. indicate "accepted with reservation" on the packing list and within 8 days inform Falper about the damage by registered letter.
 - The Company is forced to accept only orders whose value exceeds € 105,00 (with the exception of orders for spare parts). Orders received and complying with be prepared and held in case additional articles should be required.
 - The eventual returned of the goods will be accepted only if previously authorized from our direction and will have to arrive at our factory in Ozzano with carriage paid. However the returned will be burdened with 20% for general expenses with also eventual other expenses due to customer's carelessness.
 - Particular wooden packings or pallets eventually needed will be invoiced at cost.
 - FALPER reserves it self the right to make some technic and aesthetic changes that could result necessary for technical reasons in its models without any notice.
 - For each controversy relative to the present concordance between the parts and/or to the single buying and selling contracts, is exclusively competent the Bologna Court.
 - The above-mentioned conditions are intended as fully accepted with the order conferment.

- Die Preise verstehen sich ausschließlich Mehrwertsteuer, frei ab Werk.
 - Die Bereitstellungs- und Lieferfristen dürfen nicht als grundlegend verstanden werden, sie werden bei Annahme des Auftrags angegeben; auf keinen Fall sind diese jedoch bei Verspätungen, die Fällen von höherer Gewalt oder Ursachen, die nicht eindeutig der Verkäuferfirma zuzuschreiben sind, bindend. Es wird hiermit vereinbart, daß keine Verspätung den Käufer dazu berechtigt, Schadenersatz oder eine Vertragsauflösung zu verlangen. Die Lieferung der Produkte kann auch in Form von verschiedenen Teillieferungen erfolgen.
 - Der Versand erfolgt stets auf Risiko und Gefahr des Käufers, auch denn die Ware frei Bestimmungsort verkauft wurde. Der Käufer ist verpflichtet die ankommenden Waren zu kontrollieren und eventuelle Schäden oder ein Aufbrechen von Verpackung bei der Lieferung sofort zu beanstanden. Dazu muss der Vermerk "Warenannahme unter Vorbehalt" auf dem Lieferschein angegeben werden. Eventuelle Schäden müssen außerdem innerhalb von 8 Tagen der Firma Falper per Einschreiben mitgeteilt werden.
 - Aufträge, deren Gesamtpreis unter € 105,00 netto liegt, werden nicht ausgeführt, jedoch in Erwartung von eventuellen Zusatzaufträgen bereitgehalten. Davon sind Ersatzteilbestellungen ausgenommen.
 - Eine eventuelle Warenrücksendung wird nur dann akzeptiert, wenn sie zuvor von unserer Geschäftsleitung bewilligt worden ist. Die Waren müssen frachtfrei in unser Werk in Ozzano gesandt werden. Auf die zurückgesandten Waren werden 20% für allgemeine Kosten berechnet, sowie eventuell weitere Kosten, falls der Kunde unvorsichtig gehandelt hat.
 - Spezielle Verpackungen aus Holz oder eventuell notwendige Paletten werden zum Kostenpreis verrechnet.
 - FALPER behält sich das Recht vor, ohne vorherige Benachrichtigung auf ihren Modellen technische oder das Aussehen betreffende Veränderungen anzubringen, falls diese notwendig sind.
 - Falls in Verbindung mit dieser Vereinbarung und/oder den einzelnen Verkaufsverträgen zwischen den Handelspartnern Rechtsstreite entstehen sollten, ist nur das Gericht von Bologna zuständig, wobei der Käufer ausdrücklich darauf verzichtet, sich an andere Gerichte zu wenden, auch im Falle von Konnexität.
 - Die oben aufgeführten Bedingungen gelten bei Eingang des Auftrags als vollständig angenommen.
-
- Les prix n'incluent pas la TVA et sont franco notre établissement.
 - Les délais prévus pour la préparation et la livraison sont primordiaux et seront indiqués sur le bon de commande; les retards dus pour causes de force majeure ou, dans tous les cas, dont le vendeur n'est pas complètement considéré responsable sont cependant exclus. On convient toutefois qu'aucun retard ne donnera à l'acheteur le droit d'être indemnisé pour les dommages ou résilier le contrat. La livraison des produits pourra également avoir lieu en plusieurs livraisons successives partielles.
 - La marchandise voyage toujours au risque et péril de l'acheteur, même dans le cas de ventes franco destination. L'acheteur est tenu de contrôler la marchandise à son arrivée et de signaler les dommages et les détériorations des emballages au moment du déchargement, en formulant des "réserves" sur le bulletin de livraison et en communiquant à Falper l'ampleur des dommages éventuels, dans un délai de 8 jours, par courrier recommandé.
 - Les commandes inférieures à € 105,00 au net ne seront pas exécutées et seront cependant tenues en considération dans l'attente de suppléments éventuels. Les pièces de rechange éventuelles sont bien sûr exclues.
 - Le retour éventuel de la marchandise ne sera accepté qu'après autorisation préalable de notre direction et devra cependant parvenir franc de port auprès de nos établissements d'Ozzano. Dans tous les cas, on appliquera une augmentation de 20% pour les frais généraux sur la marchandise rendue, outre à des frais éventuels dus à la négligence du client.
 - Des emballages particuliers nécessaires en bois ou palettes seront facturés selon leur coût.
 - La société Falper se réserve le droit de modifier sans préavis ses propres modèles en cas de nécessité du point de vue technique ou esthétique.
 - Pour tout litige concernant le présent accord entre les parties et /ou les contrats de vente individuels, la compétence sera exclusivement du tribunal de Bologne et l'acheteur devra expressément renoncer à d'autres tribunaux, ne serait-ce qu'à titre de simple liaison.
 - On considère que les conditions ci-dessus sont intégralement acceptées simultanément à l'arrivée de la commande.

- Los precios son IVA excluida, franco nuestro establecimiento.
- Los plazos previstos para la preparación y la entrega no deben ser considerados como esenciales y serán indicados en la Aceptación del Pedido; salvo, de todos modos, los retrasos en los que pudieren influir causas de fuerza mayor o, por cualquier otra causa no plenamente imputable a la Vendedora. Se conviene, de todos modos, que ningún retraso podrá dar derecho al Comprador al resarcimiento de daños o a resolución del contrato. La entrega de los productos podrá efectuarse mediante entregas sucesivas y parciales.
- La mercancía se transporta siempre a riesgo y peligro del comprador incluso cuando haya sido vendida franco destino. El comprador tiene que controlar la mercancía al recibirla reclamando eventuales daños o alteraciones de los embalajes al descargar, indicando "la aceptación con reserva" en el albarán de entrega o documento de porte y comunicando a Falper la importancia de los daños dentro de 8 días por carta certificada.
- No se despacharán pedidos inferiores a € 105,00 netos, que de todos modos se tendrán en consideración en espera de eventuales aumentos del pedido. Por todo lo antes expuesto se excluyen eventuales piezas de recambio.
- La mercancía devuelta será aceptada sólo si hubiera sido previamente autorizada por nuestra Dirección y tendrá que enviarse con porte pagado a nuestro establecimiento de Ozzano. De todos modos la mercancía sufrirá un aumento del 20% por gastos generales, además de cualquier otro gasto debido al descuido del Cliente.
- Embalajes especiales de madera o palets eventualmente necesarios serán facturadas al costo.
- FALPER se reserva el derecho de aportar las modificaciones técnicas y estéticas a sus propios modelos, que pudieran ser necesarias, sin previo aviso.
- Por cualquier controversia relativa al presente acuerdo entre las Partes y/o a cada contrato de compraventa, es exclusivamente competente el fuero de Bolonia renunciando expresamente el Comprador a la competencia de otros Tribunales, incluso a título de conexión.
- Las condiciones citadas se consideran aceptadas integral y contextualmente al recibir el pedido.

